



4080T

TRACKED CONVEYOR



**EFFICIENT MATERIAL
HANDLING**



FEATURES

HYDRAULICALLY ADJUSTABLE HEIGHT

Adjustable discharge height up to 11 meters
Adjustable feed in height allows seamless integration with material processing equipment



HYDRAULIC FOLDING HEAD SECTION FOR TRANSPORT

Minimized set up time with hydraulic fold and unfold.
Hydraulic tail folding option available



POWERED BY CAT

CAT C2.2 55Kw (75Hp) Engine
U.S. EPA & CARB Tier 4 Final, EU Stage V
LRC Engine option available



DURABLE AND HEAVY DUTY DESIGN

Equipped with Hardox liners in the feed boot and a heavy duty impact bed built to withstand harsh conditions
Superior durability and extended service life

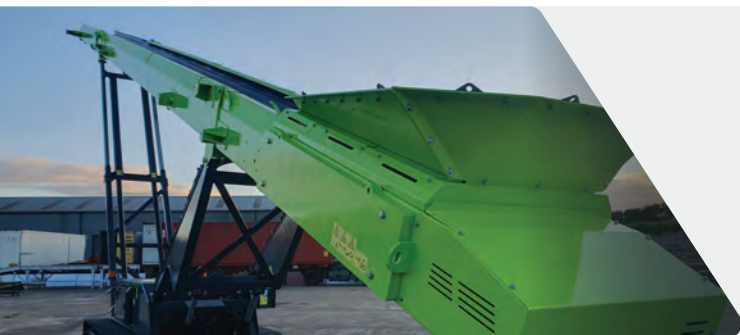

SUPERIOR MANEUVERABILITY & STABILITY

4-Meter tracks offer exceptional stability and maneuverability in challenging terrains, ensuring smooth operation even in difficult environments



EFFICIENT HANDLING FOR VARIOUS MATERIALS.

-  Compost & Mulch
-  Aggregates
-  Coal
-  C&D Waste
-  Topsoil



WWW.TERRACON.CO.UK

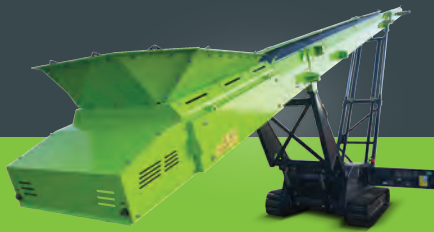

4080T TRACKED CONVEYOR

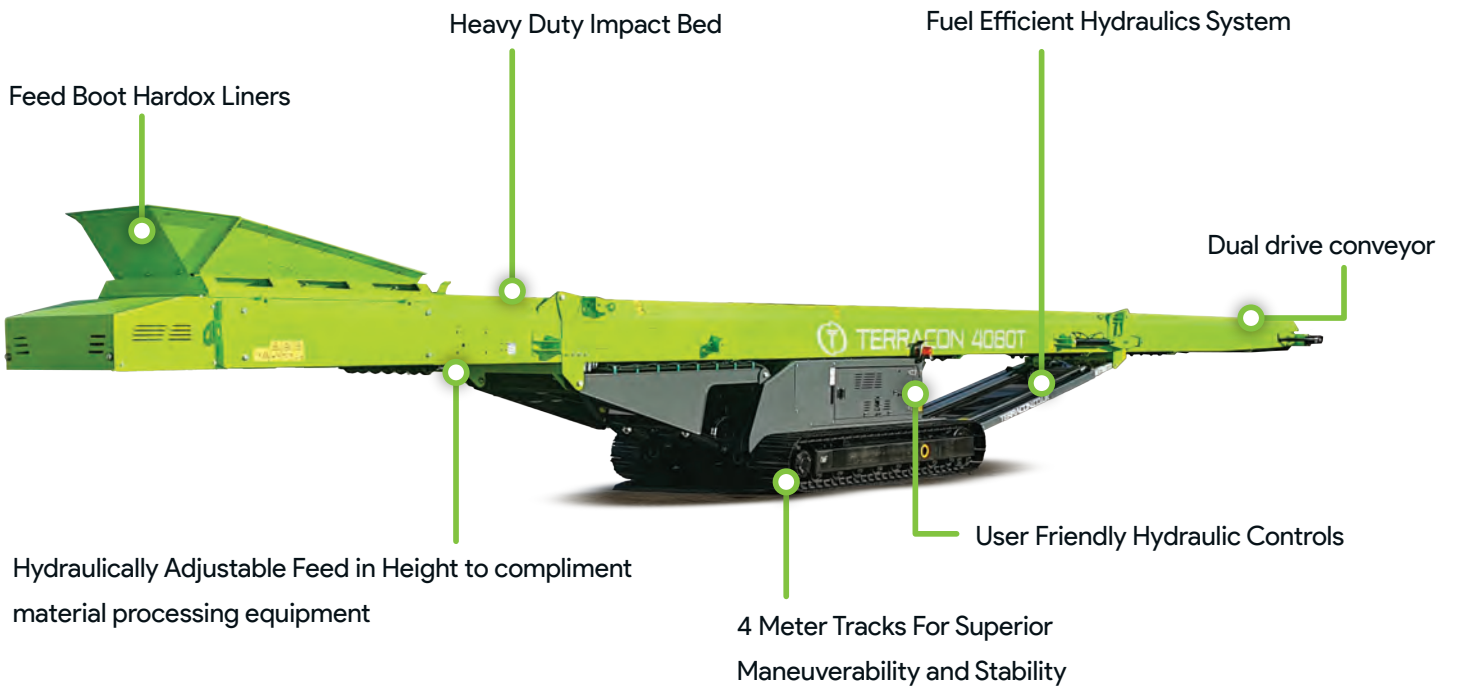

PERFORMANCE SPECIFICATION

Engine	Weight	Conveyor Belt Width	Stock Pile Height	Production Rate
CAT C2.2 55Kw (74Hp)	12,700kgs	1000mm (40")	36ft (9.5m)	Up to 800 TPH
WIDTH WORKING	LENGTH WORKING	WIDTH TRANSPORT	LENGTH TRANSPORT	HEIGHT TRANSPORT
7'-8" (2.34m)	77'-3" (23.5m)	7'-8" (2.34m)	38'-8" (11.7m)	8'-6" (2.6m)

WWW.TERRACON.CO.UK



TERRACON

WWW.TERRACON.CO.UK

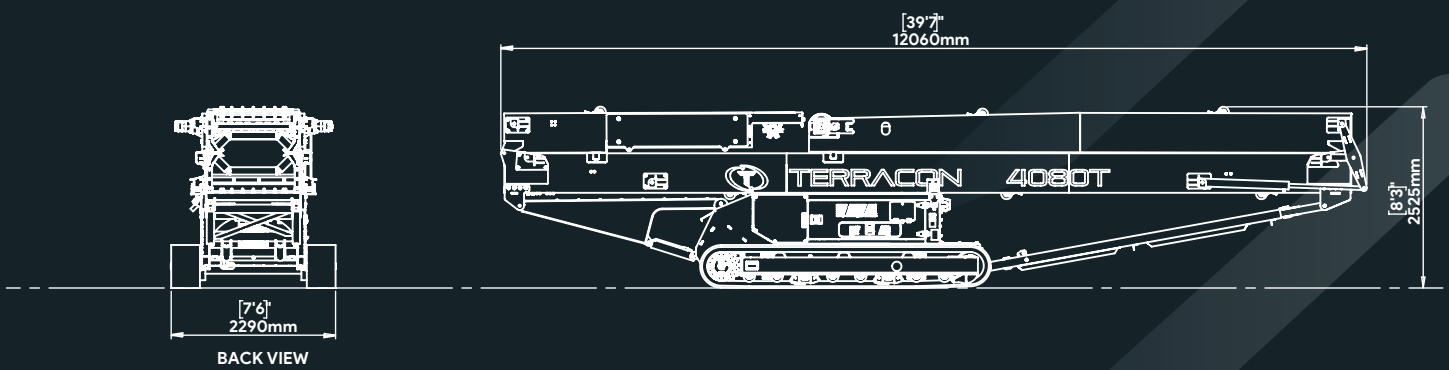
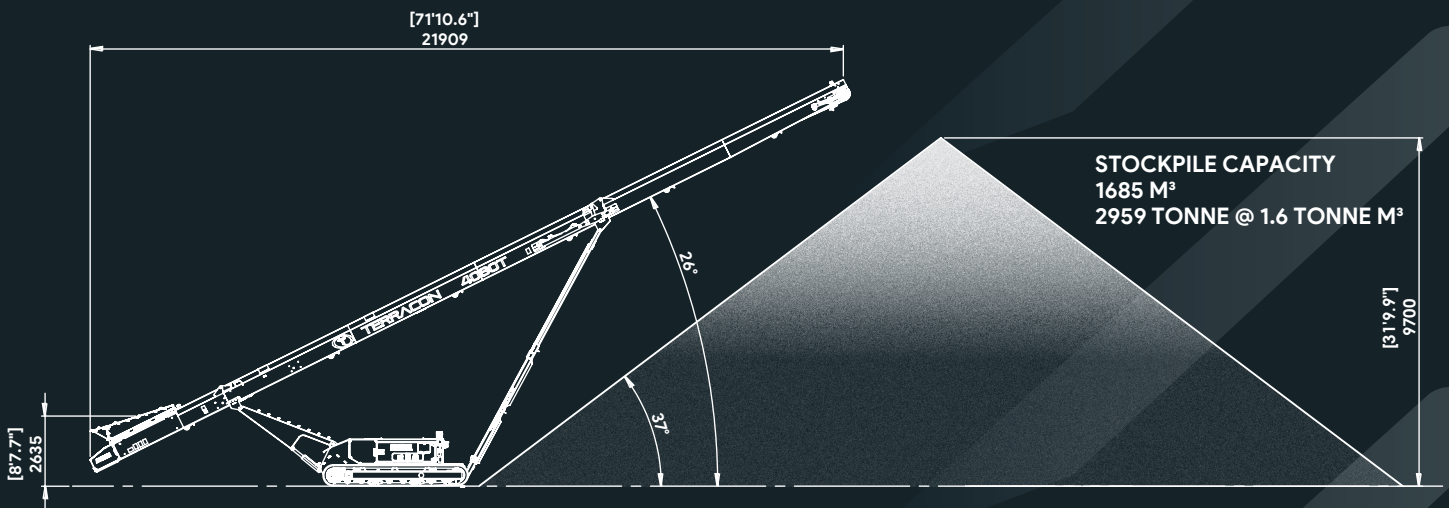

CONTACT

 Ronan Valley Business Park
58 Ballyronan Road,
Magherafelt | Co. Derry | BT456EW

 +44 28 7944 1099

 info@terracon.co.uk

CONTACT US HERE

